



Kataloglarımızda bulunan profil çizimleri örnek olarak konulmuştur.
Müşterilerimize ait olan çizimlerin profilleri satılamaz.

Profile drawings in our catalogues are given as examples only.
Profiles in drawings belonging to our customers are not for sale.

Les profilés qui figurent dans nos catalogues sont présentés à titre d'exemple.
Les profilés fabriqués à partir des dessins de nos clients ne sont pas mis à la vente.

Чертежи профилей из наших каталогов приложены в качестве образцов.
Профили, выполненные по чертежам наших клиентов, не продаются.

BÖLME KOMPOZİT PANEL
PARTITION COMPOSITE PANEL
PANNEAUX COMPOSITES DE SEPARATION
КОМПОЗИТНАЯ ПАНЕЛЬ ДЛЯ ПЕРЕГОРОДОК

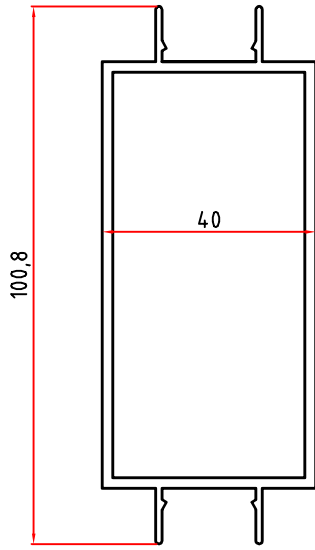

1932
1,399 Kg/m

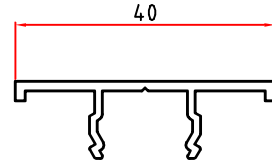

1933
0,250 Kg/m

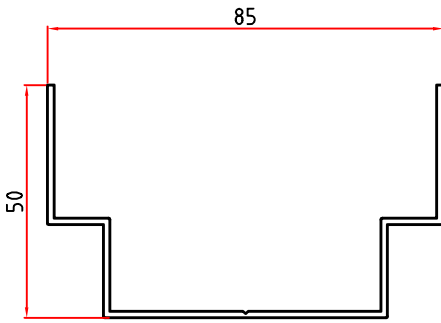

2474
0,725 Kg/m

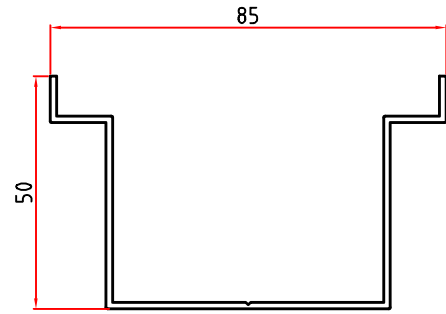

2475
0,725 Kg/m

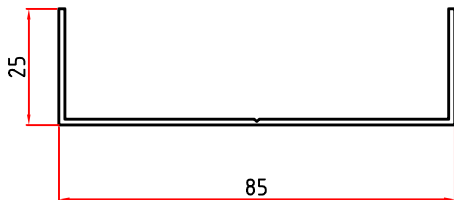

2476
0,489 Kg/m

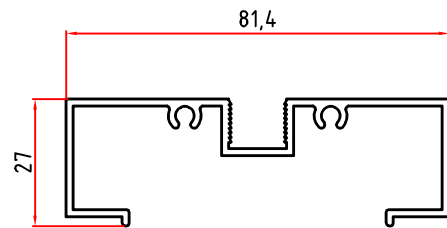

2477
0,857 Kg/m

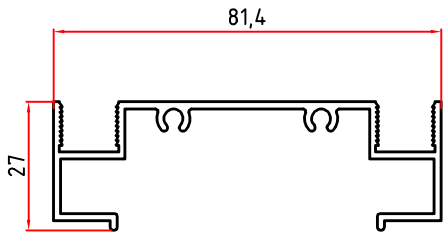

2478
0,854 Kg/m

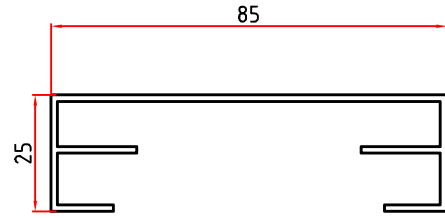

2479
0,757 Kg/m

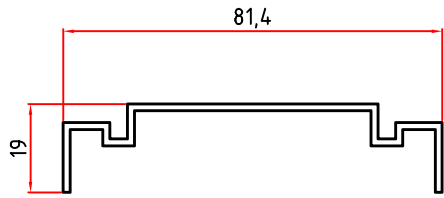

2480
0,556 Kg/m

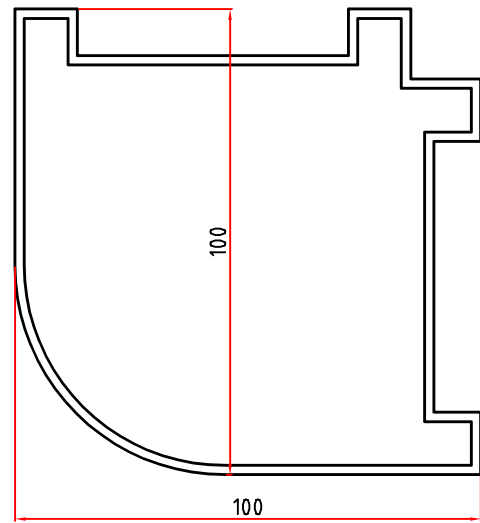

2481
2,351 Kg/m

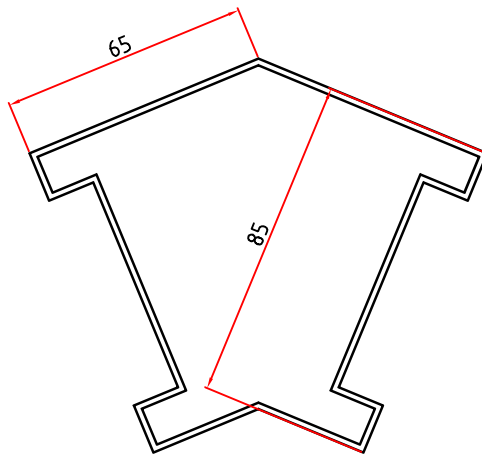

2483
1,835 Kg/m

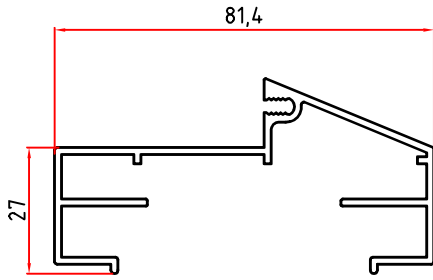

2514
0,974 Kg/m

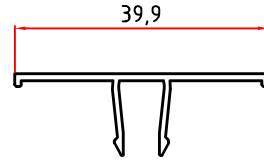

4826
0,197 Kg/m

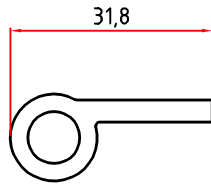

2522
0,465 Kg/m

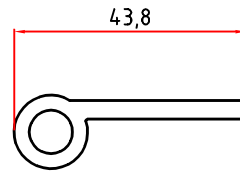

2523
0,654 Kg/m

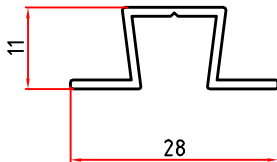

2482
0,170 Kg/m

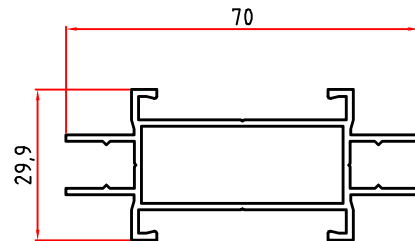

4825
0,811 Kg/m

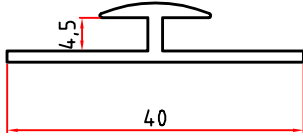

1978
0,248 Kg/m

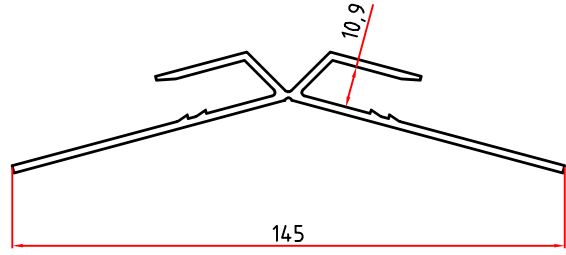

3168
1,279 Kg/m

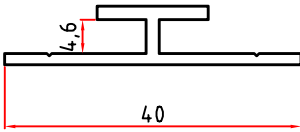

3925
0,271 Kg/m

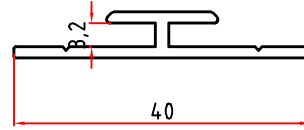

5753
0,248 Kg/m

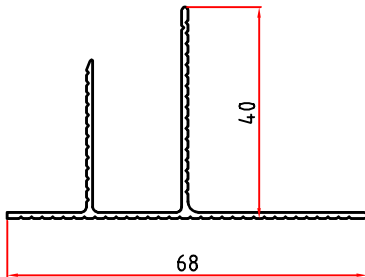

6138
0,435 Kg/m

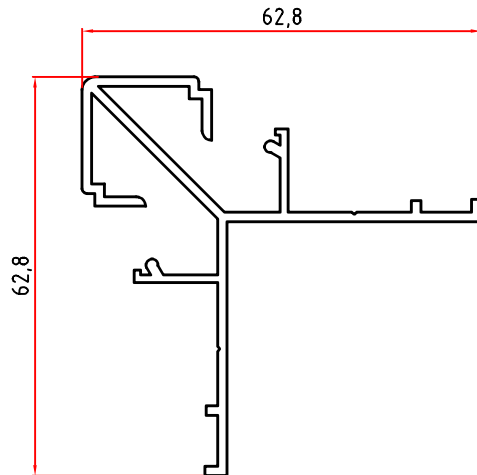

6155
0,857 Kg/m

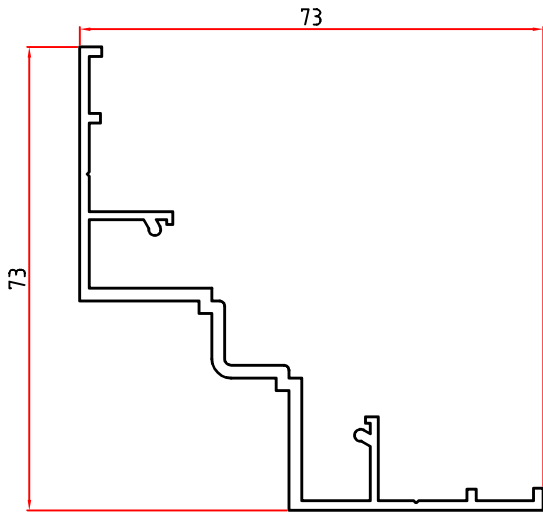

6156
0,861 Kg/m

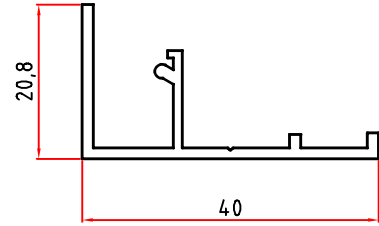

6157
0,331 Kg/m

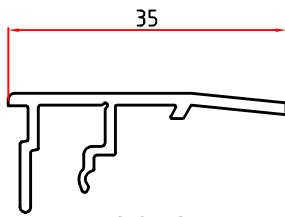

6158
0,255 Kg/m

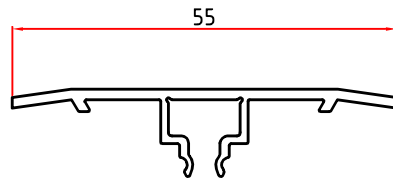

6159
0,336 Kg/m

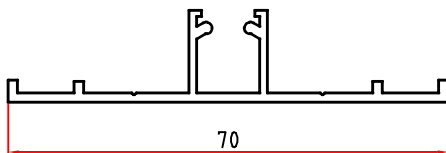

6160
0,453 Kg/m

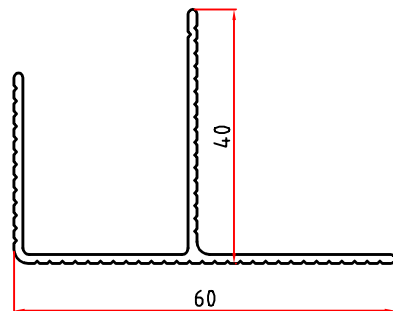

6202
0,479 Kg/m