



Kataloglarımızda bulunan profil çizimleri örnek olarak konulmuştur.
Müşterilerimize ait olan çizimlerin profilleri satılamaz.

Profile drawings in our catalogues are given as examples only.
Profiles in drawings belonging to our customers are not for sale.

Les profilés qui figurent dans nos catalogues sont présentés à titre d'exemple.
Les profilés fabriqués à partir des dessins de nos clients ne sont pas mis à la vente.

Чертежи профилей из наших каталогов приложены в качестве образцов.
Профили, выполненные по чертежам наших клиентов, не продаются.

BİLGİSAYAR DOLAP PROFİLLERİ
COMPUTER TABLE PROFILES
PROFILES POUR RACKS D'ORDINATEURS
ПРОФИЛИ КОМПЬЮТЕРНЫХ ШКАФОВ

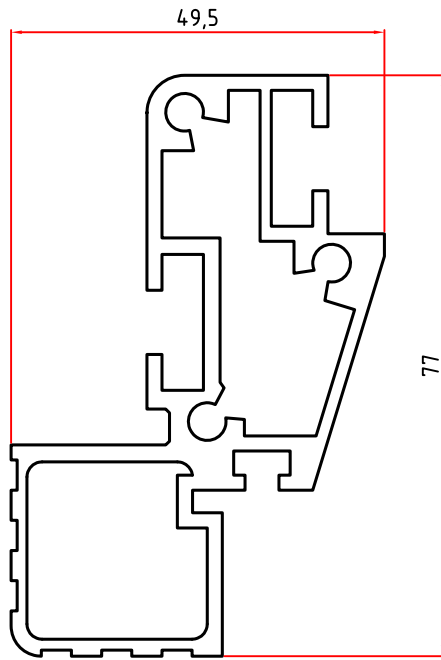

1691
1,849 Kg/m

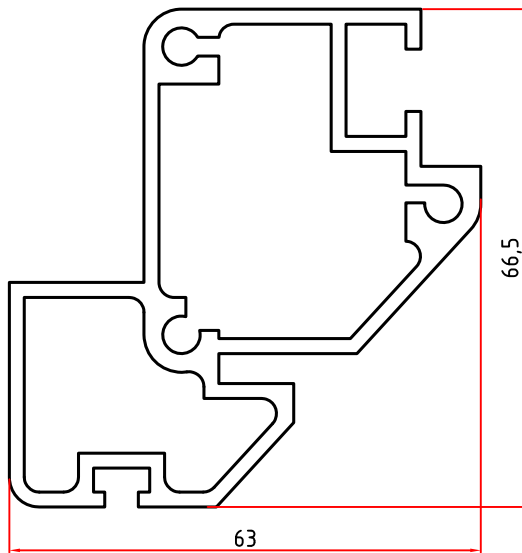

1774
1,965 Kg/m

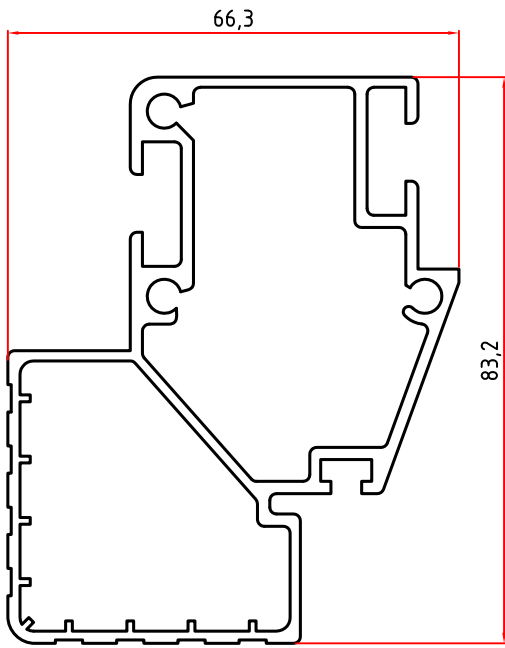

2119
1,932 Kg/m

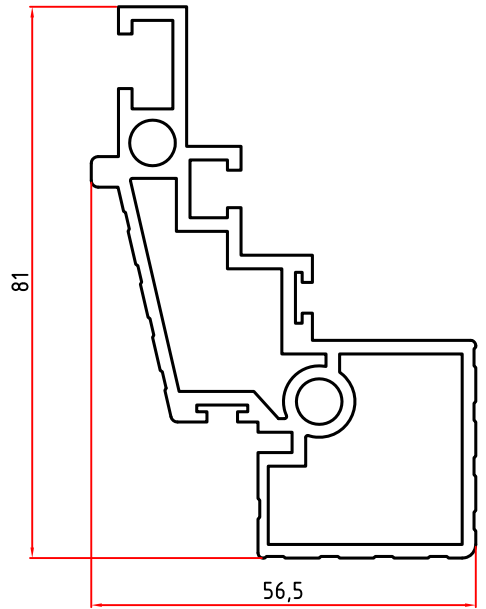

2629
1,829 Kg/m

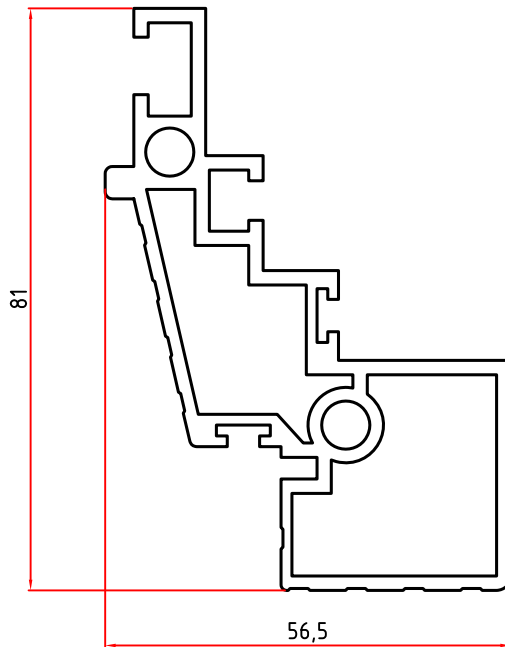

4022
1,808 Kg/m

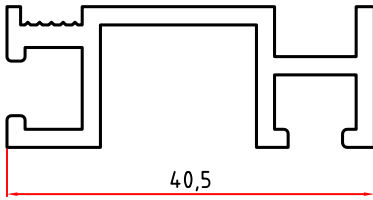

2628
0,563 Kg/m

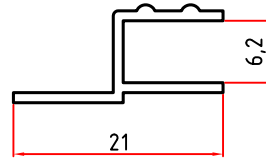

2630
0,115 Kg/m

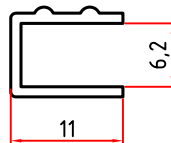

2631
0,084 Kg/m

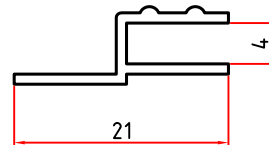

3538
0,110 Kg/m

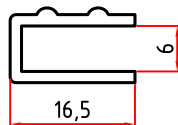

3539
0,078 Kg/m

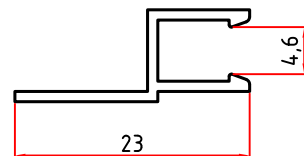

4036
0,118 Kg/m

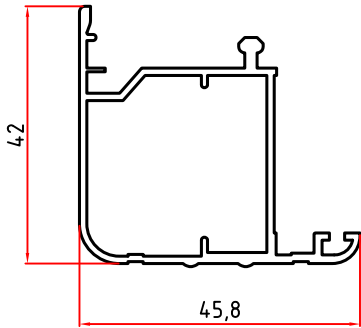

2452
0,627 Kg/m

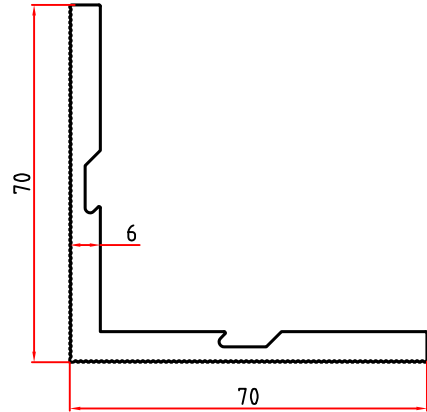

2453
2,053 Kg/m

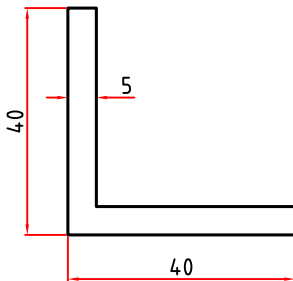

2462
1,067 Kg/m

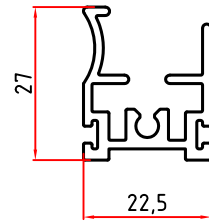

2463
0,502 Kg/m

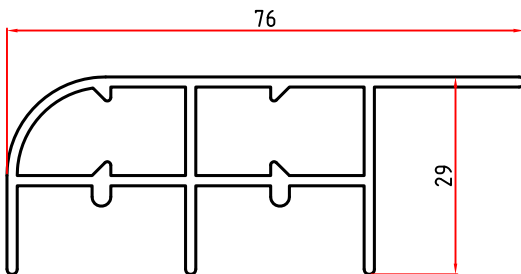

2464
0,941 Kg/m

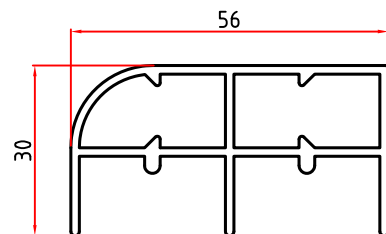

2465
0,878 Kg/m

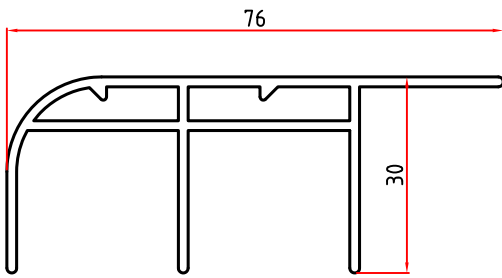

2485
0,882 Kg/m

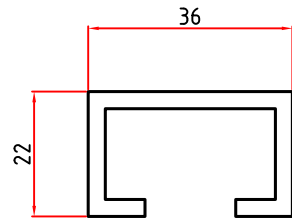

5304
0,751 Kg/m

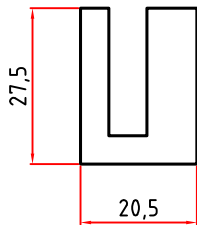

5305
1,175 Kg/m

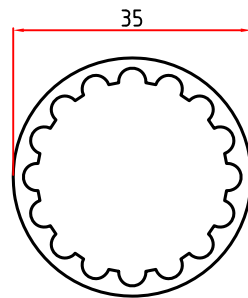

5306
0,690 Kg/m

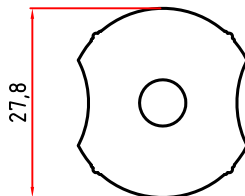

5307
1,483 Kg/m

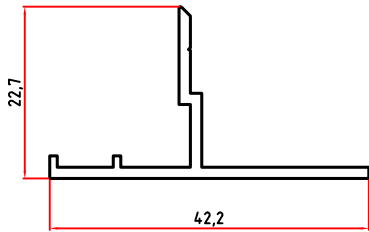

5309
0,283 Kg/m

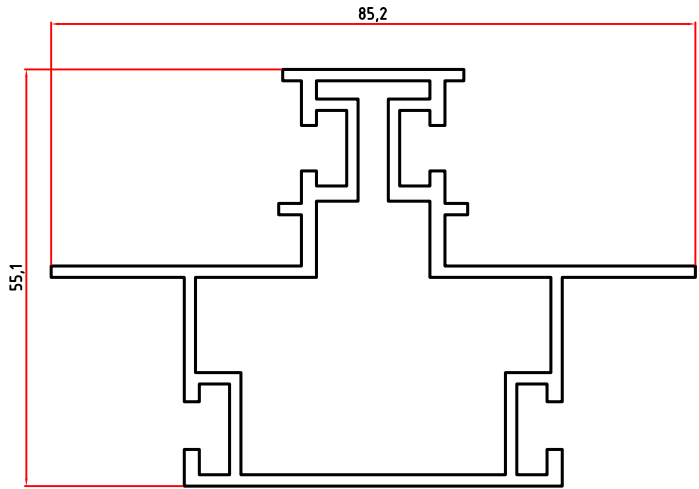

5310
1,385 Kg/m

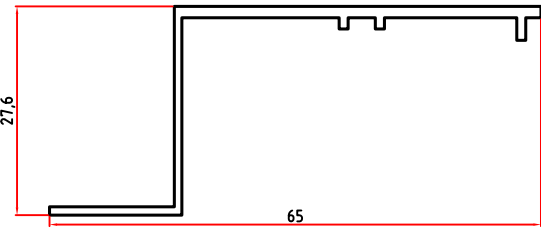

5311
0,353 Kg/m

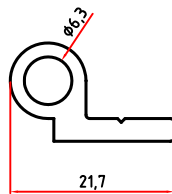

5317
0,285 Kg/m

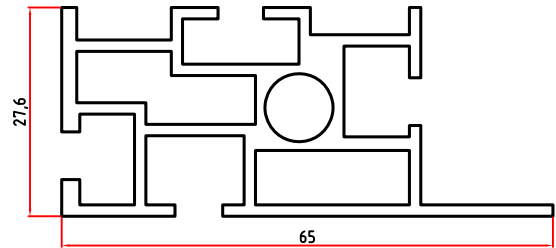

5312
1,180 Kg/m

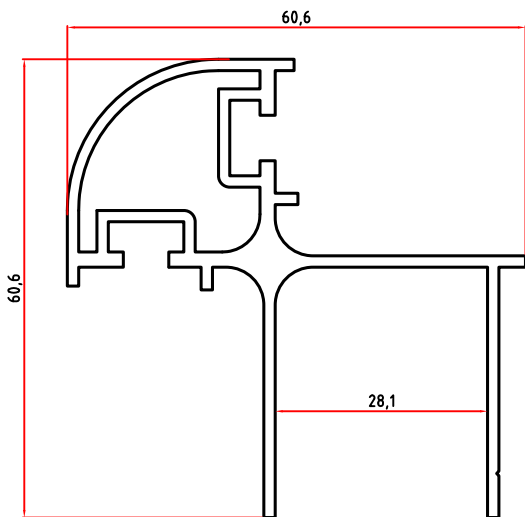

5313
1,118 Kg/m

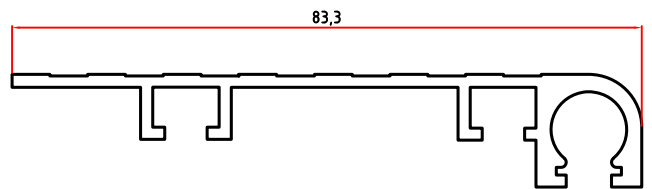

5337
0,721 Kg/m